

Photos non contractuelles / Photos not contractual



- Système dynamique
- contrôle automatique
- Nombre de poches : 205
- Poids des pâtons de 50 à 650 gr
- Fonctionnement silencieux
- Roulettes
- Comptage de pâtons digital
- Conçu pour des pâtons de différentes tailles
- Lampe germicide
- Plateau de récupération
- Rampe de sortie (au choix) à droite ou à gauche
- 400/50-60Hz/3
- Puissance : 1 kW
- Poids 620 kg

Options :

- Climatiseur
- Poches individuelles nylon

- Dynamic system
- Automatic control
- Pockets number : 205
- Dough piece weight : from 50 to 650g
- Silent and quick operation
- Rotary wheels
- Dough pieces digital counter
- Designed for different sizes of pieces
- Germicidal lamp
- Flour drawer
- Output on the right or on the left (on choice)
- 400/50-60Hz/3
- Power : 1 kW
- Net weight : 620 kg

Options :

- Refrigerator unit
- Individual nylon pockets

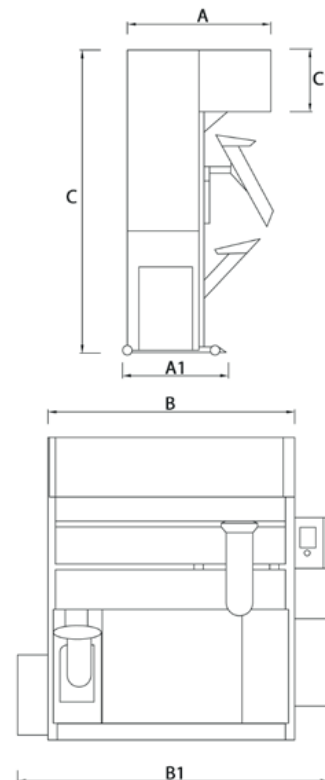

A = 1015 mm
A1 = 680 mm
B = 1355 mm
B1 = 1555 mm
C = 2520 mm
C1 = 480 mm

